



METER

ZSC



TABLE OF CONTENTS

1. Introduction	1
2. Operation	3
2.1 Connecting With Stereo Connector	3
2.2 Connecting With Pigtail Adapter	5
2.3 Viewing Sensor Data	5
2.4 Changing Sensor Units	7
2.5 Changing Digital Sensor SDI-12 Address	9
2.6 Sensor-Specific Functionality	10
3. System	11
3.1 Specifications	11
3.2 Components	12
4. Service	13
4.1 Maintenance	13
4.2 ZSC Firmware Update	13
4.3 Troubleshooting	15
4.4 Customer Support	17
4.5 Terms and Conditions	18
Appendix A. Compliance Certifications	19
Index	21

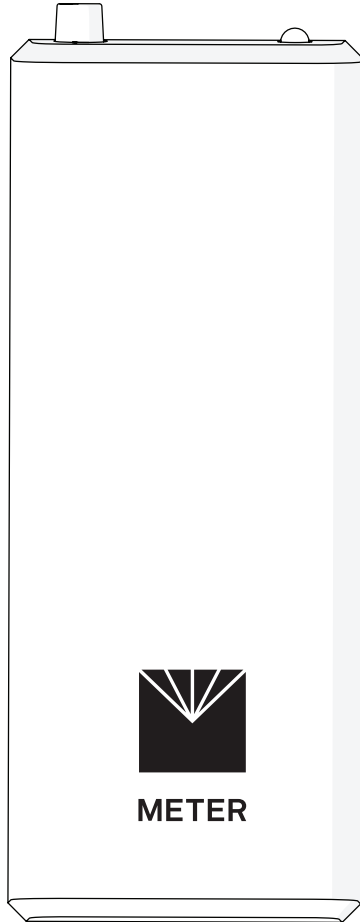

1. INTRODUCTION

Thank you for choosing the ZSC Bluetooth® Sensor Interface from METER Group.

The ZSC is a hardware accessory to support METER ZENTRA system sensors. The ZSC pairs wirelessly with iOS™ and Android™ mobile devices through the ZENTRA Utility Mobile app to display sensor measurement data and metadata (firmware version, serial number, etc.). The ZSC works with most analog, pulse, and digital sensors supported by the ZENTRA system. Changing the sensor SDI-12 address for use on third-party loggers is also supported.

Verify the ZSC and its two AA alkaline batteries appear in good condition.

The latest version of the ZENTRA Utility Mobile app must be downloaded from the device's app store (Figure 1) or the ZENTRA Apps website (Figure 2) prior to connecting to a sensor and viewing sensor data.

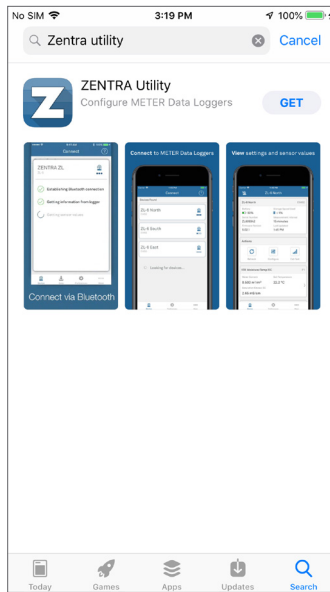

Figure 1 ZENTRA Utility Mobile app



Figure 2 QR code to ZENTRA Apps website

INTRODUCTION

Use the In-App Tutorial to become familiar with the app screens and capabilities prior to connecting to a sensor (Figure 3).

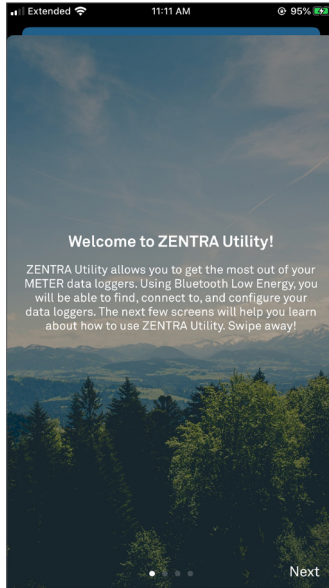

Figure 3 ZENTRA Utility Mobile In-App Tutorial

2. OPERATION

Please read all instructions before operating the ZSC to ensure it performs to its full potential.

PRECAUTIONS

METER instruments are built to the highest standards, but misuse, improper protection, or improper installation may damage the sensor and possibly void the manufacturer's warranty. Before using the ZSC, follow the recommended user instructions and arrange proper protections to safeguard the instrument from damage.

2.1 CONNECTING WITH STEREO CONNECTOR

The ZSC communicates with mobile devices through Bluetooth® Low Energy (BLE) and the ZENTRA Utility Mobile app (available for iOS and Android). The latest version of the app must be downloaded prior to connecting to a sensor and viewing sensor data ([Section 1](#)).

1. Insert the two AA batteries (included) into the ZSC ([Figure 4](#)).

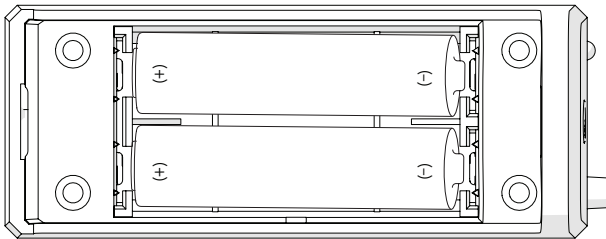

Figure 4 Batteries in the ZSC

2. Plug the sensor stereo connector into the ZSC stereo port ([Figure 5](#)).

NOTE: If the sensor has three stripped and tinned wires, contact [Customer Support](#) to purchase a pigtail-to-stereo adapter cable to use with the ZSC. See [Section 2.2](#) for using the adapter.

OPERATION



Figure 5 Plug sensor cable into ZSC

3. Press the button on the ZSC.
4. Confirm that the LED on the ZSC begins blinking blue.
5. Open ZENTRA Utility Mobile app on the mobile device.

The **Connect** screen will appear. ZENTRA Utility Mobile will search for and display nearby Bluetooth-enabled ZENTRA devices (**Figure 6**).

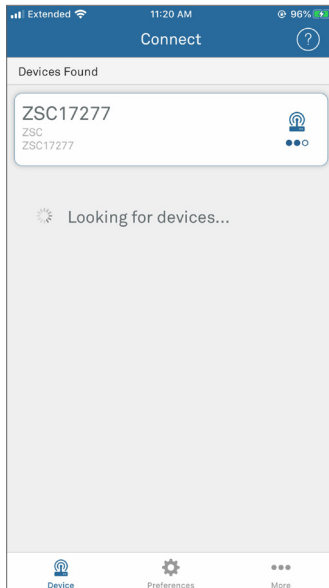

Figure 6 Connect screen with ZSC

6. Select the ZSC.

The ZSC main screen will appear. The ZSC is connected and ready to show sensor measurements ([Section 2.3](#)).

2.2 CONNECTING WITH PIGTAIL ADAPTER

For METER sensors to be used with non-METER loggers, the connection may have been stripped and tinned. To connect these sensors back to the ZSC or other METER loggers, a pigtail-to-stereo adapter cable will be needed. Contact [Customer Support](#) to obtain an adapter cable.

The adapter cable has a connector for the stereo plug connector on one end and three wires (or pigtail adapter) for connection to a data logger on the other end. The stripped and tinned wires have the same termination as in [Figure 7](#): the brown wire is excitation, the orange is output (either digital or analog, depending on the sensor), and the bare wire is ground. Connect each end of the adapter cable to the corresponding color on the stripped cable. Plug the adapter stereo connector to the ZSC ([Section 2.1](#)).

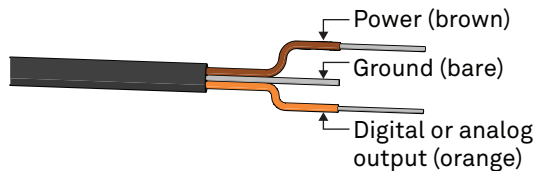

Figure 7 Pigtail wiring

NOTE: Some early adapters may have the older wiring scheme where the power supply is white, the output is red, and the bare wire is ground.

After the sensor is properly connected to the pigtail adapter, follow the instructions in [Section 2.1](#) to connect the adapter to the ZSC.

2.3 VIEWING SENSOR DATA

After connecting the ZSC and the sensor ([Section 2.1](#)), the most recent scan of the connected sensor will show on the screen ([Figure 8](#)).

OPERATION

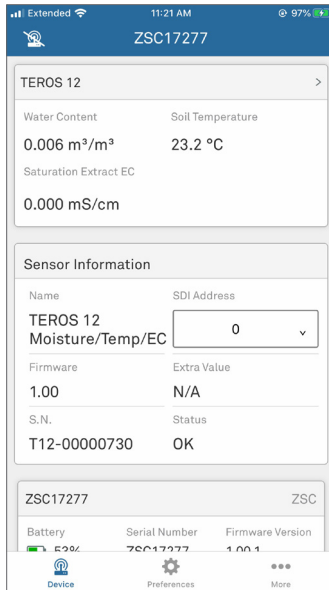

Figure 8 Measurement screen

If the sensor is not automatically recognized, choose the sensor from the dropdown list (Figure 9).

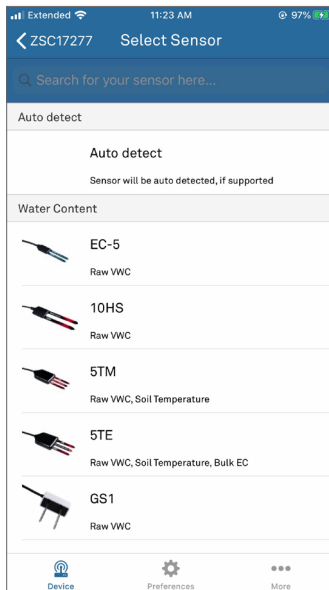

Figure 9 Select Sensor menu

Swipe down to refresh the measurements as desired.

2.4 CHANGING SENSOR UNITS

The displayed sensor units can be changed at any time through the ZENTRA Utility Preferences menu.

NOTE: Device Defaults in the Preferences menu do not apply to the ZSC. Defaults apply to METER data loggers only.

1. Select Preferences at the bottom of the Measurement screen (Figure 10).

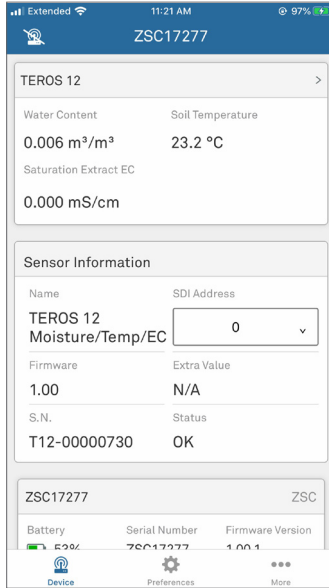

Figure 10 Select Preferences

2. Select on the measurement of interest (Figure 11).

OPERATION

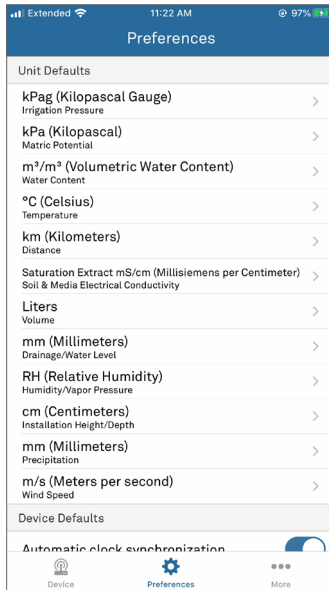

Figure 11 Select measurement of interest

3. Scroll through the units to highlight the desired units (Figure 12).

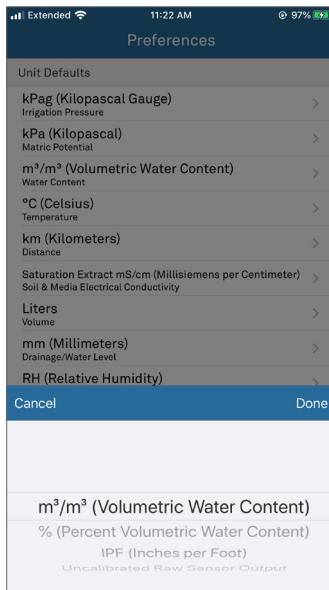

Figure 12 Changing preferred units

4. Select **Done** to save changes.
Select **Cancel** to exit without saving changes.
5. Select **Device** at the bottom of the screen to return to the connected ZSC.
6. Swipe down to refresh the measurement page and see the new units.

2.5 CHANGING DIGITAL SENSOR SDI-12 ADDRESS

METER digital sensors have the default SDI-12 address of 0. If the sensors are being used with a non-METER logger using SDI-12 protocol on a bus, use the ZSC and the ZENTRA Utility Mobile app to change the sensor SDI-12 address. See the individual sensor integrator guide for more information about the SDI-12 protocol in the sensors.

NOTE: The sensor SDI-12 address must be 0 to work with ZENTRA loggers.

1. Open the ZENTRA Utility Mobile app ([Section 1](#)).
2. Connect the sensor to the ZSC ([Section 2.1](#)).
3. Under Sensor Information, select the SDI Address dropdown ([Figure 13](#)).

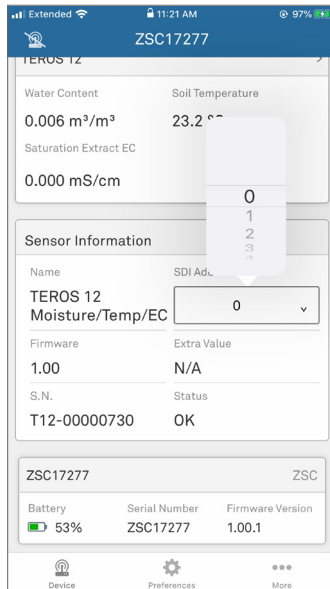

Figure 13 SDI-12 Address dropdown

4. Scroll through the options and select the desired SDI-12 address.

NOTE: Address options include 0-9, A-Z, and a-z.

2.6 SENSOR-SPECIFIC FUNCTIONALITY

The ZSC can also perform some sensor-specific functionalities. Consult the specific sensor manual for details on how to use these functionalities.

- ATMOS 41 pyranometer calibration coefficient changes after funnel component replacement ([ATMOS 41 Manual](#))
- ATMOS 22/41 Wind Speed Zero ([ATMOS 41 Manual](#))

3. SYSTEM

This section describes the specifications and components of the ZSC.

3.1 SPECIFICATIONS

COMMUNICATION SPECIFICATIONS

Measurement Time

<1 s (depends on sensor)

Device Operating System Compatibility

Android OS 4.3 or greater

NOTE: Location services must be enabled to use the Bluetooth capabilities of the ZSC. This is a requirement set by the Android operating system (OS).

iOS 10 or greater

Sensor Input Port

3.5-mm stereo plug connector (supports METER analog, digital, or pulse sensors)

NOTE: A pigtail-to-stereo adapter cable can be ordered to connect sensors with pigtail wiring ([Section 2.2](#)).

PHYSICAL SPECIFICATIONS

Dimensions

Length 3.60 in (9.14 cm)

Width 1.44 in (3.66 cm)

Height 1.32 in (3.35 cm)

Operating Temperature Range

Minimum -40 °C

Typical NA

Maximum 50 °C

NOTE: Sensors may be used at higher temperatures under certain conditions; contact [Customer Support](#) for assistance.

Data Storage

None

Power

Two AA alkaline batteries

Battery Life

Approximately 2 to 3 months with normal use and up to 6 months with daily use.

Enclosure

UL94 HB, RoHS-compliant ABS plastic

COMPLIANCE

EM ISO/IEC 17050:2010 (CE Mark)

Additional compliance information is in [APPENDIX A](#).

3.2 COMPONENTS

The ZSC has a single button to wake the ZSC and enable Bluetooth connections ([Figure 14](#)). There is also an LED to indicate the unit status:

- Off: the ZSC is in sleep mode
- Blinking: the ZSC is advertising and ready to connect
- Solid Blue: the ZSC is connected via Bluetooth to a device
- Blinking Red: the batteries are too low to take a measurement
- Blinking Red and Purple: the firmware of the ZSC is being updated.

The ZSC is powered by two AA alkaline batteries.

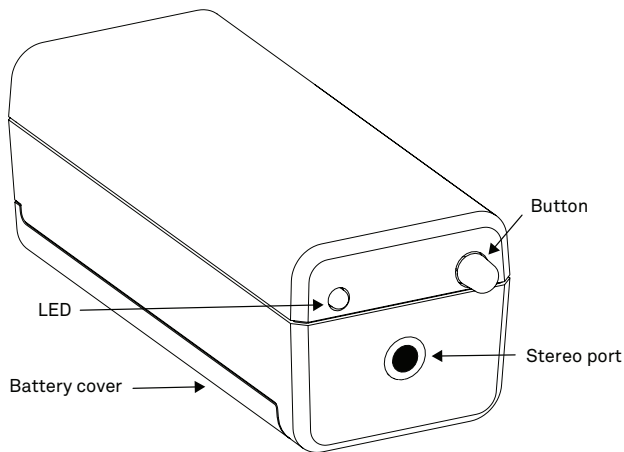

Figure 14 ZSC components

4. SERVICE

This section describes maintenance and updates for the ZSC. Troubleshooting solutions and customer service information are also provided.

4.1 MAINTENANCE

The ZSC is designed for minimal maintenance and will only require a periodic change of batteries. The batteries in the ZSC will last approximately 2 to 3 months under normal use (approximately 2 h of use per day). To change the batteries of the ZSC:

1. Slide back the panel on the bottom of the case.
2. Remove the old batteries and discard.
3. Replace with new AA alkaline batteries.
4. Replace the panel on the bottom of the case.

NOTE: If the ZSC will be stored for a prolonged period (greater than 2 weeks), remove the batteries.

4.2 ZSC FIRMWARE UPDATE

METER releases firmware updates for ZSC to improve product performance. ZENTRA Utility Mobile will automatically check the firmware version upon connecting with the ZSC. If a newer firmware version exists, ZENTRA Utility Mobile will display an Update ZSC firmware banner at the top of the app screen (Figure 15).

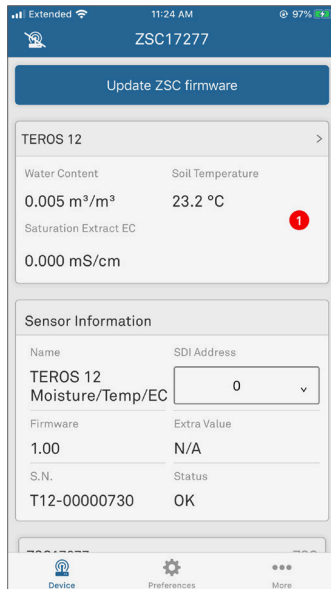

Figure 15 Update firmware banner

1. Press the **Update ZSC firmware** banner.

Additional instructions will appear on screen ([Figure 16](#)).

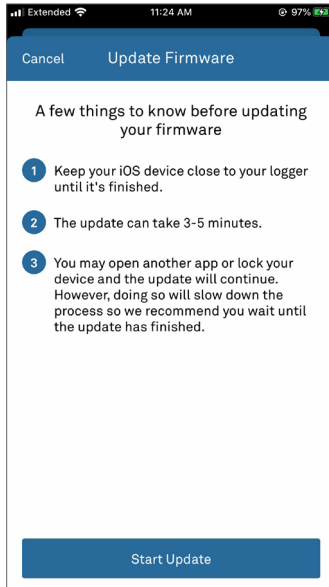

Figure 16 Notes prior to updating firmware

2. Carefully read and follow the instructions.
3. When ready, press **Start Update**.

The screen will automatically advance through the process. The app will display that the firmware was successfully updated ([Figure 17](#)).

NOTE: The firmware may take several minutes to update. This is normal.

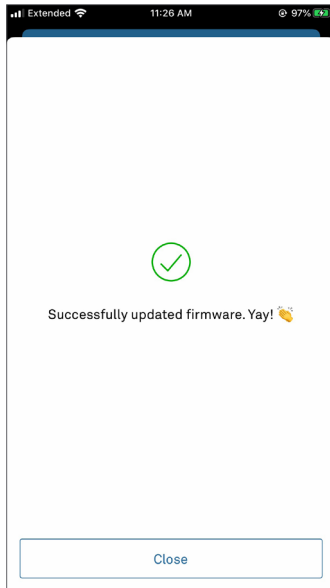

Figure 17 Firmware update confirmation

4. Select **Close**.

4.3 TROUBLESHOOTING

Table 1 lists common problems and their solutions.

Table 1 Troubleshooting the ZSC

Problem	Possible Solutions
ZSC cannot connect to Android over Bluetooth	<p>Ensure location services are enabled on the Android device.</p> <p>Ensure Bluetooth is enabled on the device.</p> <p>Check the Android OS, and confirm that it is v4.3 or higher. Upgrade the OS if necessary.</p> <p>Confirm the LED on the ZSC turns on after the button is pressed. If the light does not come on, replace the batteries in the ZSC.</p>
ZSC cannot connect to iPhone over Bluetooth	<p>Ensure Bluetooth is enabled on the device</p> <p>Check the iPhone OS, and confirm that it is v10 or higher. Upgrade the OS if necessary.</p> <p>Confirm the LED on the ZSC turns on when after the button is pressed. If the light does not come on, replace the batteries in the ZSC.</p>
LED on ZSC will not turn on	<p>Change the batteries in the ZSC.</p>

Table 2 Troubleshooting the ZSC (continued)

Problem	Possible Solutions
Sensor measurements will not show up on app	Ensure that the sensor is supported by the ZSC (only METER-brand sensors are supported). Ensure the sensor connector is fully inserted in the ZSC. Ensure proper sensor wiring if using the pigtail-to-stereo adapter.
Sensor measurement looks wrong	Ensure the sensor connector is fully inserted in the ZSC.

ZENTRA Utility Mobile app also has tools in the More screen to help troubleshoot a problem: Frequently Asked Questions pages ([Figure 18](#)) and a Send Feedback option ([Figure 19](#)). If these suggestions do not help solve the issue, contact [Customer Support](#).

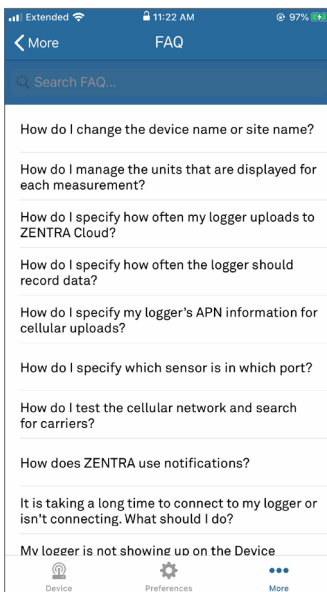
**Figure 18 FAQ list**

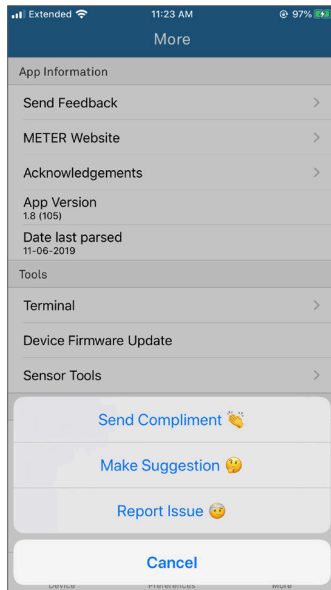

Figure 19 Send Feedback

4.4 CUSTOMER SUPPORT

NORTH AMERICA

Customer service representatives are available for questions, problems, or feedback Monday through Friday, 7:00 am to 5:00 pm Pacific time.

Email: support.environment@metergroup.com
sales.environment@metergroup.com

Phone: +1.509.332.5600

Fax: +1.509.332.5158

Website: metergroup.com

SERVICE

EUROPE

Customer service representatives are available for questions, problems, or feedback Monday through Friday, 8:00 to 17:00 Central European time.

Email: support.europe@metergroup.com
sales.europe@metergroup.com

Phone: +49 89 12 66 52 0

Fax: +49 89 12 66 52 20

Website: metergroup.com

If contacting METER by email, please include the following information:

Name	Email address
Address	Instrument serial number
Phone	Description of the problem

NOTE: For products purchased through a distributor, please contact the distributor directly for assistance.

4.5 TERMS AND CONDITIONS

By using METER instruments and documentation, you agree to abide by the METER Group, Inc. Terms and Conditions. Please refer to metergroup.com/terms-conditions for details.

APPENDIX A. COMPLIANCE CERTIFICATIONS

This appendix contains compliance statements that apply to the ZSC.

A.1 USA

This device complies with Part 15 of the FCC Rules. Operation is subject to the following conditions:

1. This device may not cause harmful interference.
2. This device must accept any interference received, including interference that may cause undesired operation.

This device contains FCC ID SH6MDBT42Q.

A.2 CANADA

Industry Canada (IC) Notices

This device complies with Industry Canada license-exempt RSS Standard(s). Operation is subject to the following two conditions:

1. This device may not cause interference.
2. This device must accept any interference, including interference that may cause undesired operation of the device.

Avis d'Industrie Canada (IC)

Le présent appareil est conforme aux CNR d'Industrie Canada applicables aux appareils radio exempts de licence. L'exploitation est autorisée aux deux conditions suivantes:

1. l'appareil ne doit pas produire de brouillage, et
2. l'utilisateur de l'appareil doit accepter tout brouillage radioélectrique subi, même si le brouillage est susceptible d'en compromettre le fonctionnement.

This device contains IC ID 8017A-MDBT42Q.

A.3 EUROPEAN UNION

The ZSC is tested to comply with CE mark requirements. A full CE declaration of conformity for the ZSC is available on request from METER.

A.4 JAPAN



® 201-160496

A.5 TAIWAN

本產品內含射頻模組:ID 編號 CCAM16LP1180T2

INDEX

B

battery **3, 11, 12, 13**

C

compliance **12, 19**

components **12**

connecting

 pigtail adapter **5–14**

 stereo connector **3–5**

customer support **17**

F

firmware update

 ZSC **13–15**

L

LED **4, 12**

M

maintenance **13**

O

operating system compatibility

 Android **1, 11, 15**

 iOS **1, 11, 15**

P

pigtail-to-stereo adapter **5**

S

SDI-12 address **9**

sensor measurements

 connecting **3–5**

 storage **11**

 units **7–9**

 view **5–6**

specifications **11–14**

communication **11**

physical **11**

T

terms and conditions **18–20**

troubleshooting **15**

V

viewing data **5–6**

Z

ZENTRA **1**

ZENTRA Utility Mobile app **1, 3**

 connecting **4**

 FAQ **16**

 In-App Tutorial **2**

 installation **1**

 Preferences **7**

 sensor-specific module **10**

 updating firmware **13–15**

METER Group, Inc.

2365 NE Hopkins Court Pullman, WA 99163
T: +1.509.332.2756 F: +1.509.332.5158
E: info@metergroup.com W: metergroup.com

METER Group GmbH

Mettlacher Straße 8, 81379 München
T: +49 89 1266520 F: +49 89 12665220
E: info.europe@metergroup.com W: metergroup.com

