

WP4C

Dew Point PotentiaMeter

Operator's Manual



METER Group, Inc.

Version: June 2, 2017 — 08:22:53

METER Group, Inc.
2365 NE Hopkins Court
Pullman WA 99163

Phone: 509-332-5600

Fax: 509-332-5158

Website: www.metergroup.com

Email: support.environment@metergroup.com or
sales.environment@metergroup.com

Trademarks

©2017 METER Group, Inc.

All Rights Reserved

Contents

1	Introduction	1
1.1	Customer Support	1
1.2	About This Manual	2
1.3	Warranty	2
1.4	Seller's Liability	2
2	About the WP4C	4
2.1	Specifications	4
2.2	WP4C and Water Potential	5
2.3	How the WP4C works	5
2.4	WP4C and Temperature	6
3	Getting Started	7
3.1	Components of your WP4C	7
3.2	Choosing a Location	7
3.3	Features	8
3.4	Preparing the WP4C for Operation	8
3.5	Portability	9
4	The Menus	11
4.1	The Main Menu	11
4.1.1	Changing Languages	11
4.1.2	Reading Modes	12
4.2	System Configuration	14
4.3	Sample Equilibration Screen	17
5	Calibration and Verification	19
5.1	Verification	19
5.2	Verification Standards	19
5.3	When to Verify Calibration	19
5.4	How to Verify and Calibrate the WP4C	20
6	Sample Preparation	22
6.1	Choosing a Sample Cup	22
6.2	Preparing the Sample	22
6.3	Dry Samples	23
6.4	Samples and Temperature	24
6.5	Measuring Plant Samples	25

6.6	Taking a Reading	25
6.7	How WP4C takes Readings	25
7	Computer Interface	27
7.1	AquaLink 4 Software	27
7.2	Using a Communication Program	28
8	Theory: Water Potential	30
8.1	Water Potential	30
8.2	Measuring Water Potential	30
8.3	Effect of Temperature on Water Potential	31
8.4	Estimating Osmotic Potential	32
9	Cleaning and Maintenance	33
9.1	Accessing the Block	33
9.2	Cleaning Procedure	34
9.3	Checking Calibration	37
10	Repair Instructions	38
10.1	Shipping Directions	38
10.2	Repair Costs	39
10.3	Loaner Service	39
11	Troubleshooting	40
11.1	Problems and Solutions	40
11.2	Sensor Performance Screen	44
12	Further Reading	46
12.1	Application Notes	46
13	Appendix A	48
13.1	Preparing Salt Solutions	48
14	Appendix B	49
15	Declaration of Conformity	50
16	Certificate of Traceability	51

1 Introduction

Welcome to METER's WP4C Dew Point PotentiaMeter, the research standard for measuring water potential. WP4C is the fastest, most accurate, and most reliable instrument available for measuring water potential using the chilled-mirror dew point technique. The WP4C suits the needs of the scientist and student. It is easy to use and provides fast, accurate results. We hope you find this manual informative and helpful in understanding how to maximize the capabilities of your WP4C.

1.1 Customer Support

There are several ways to contact METER if you ever need assistance with your product, have any questions, or feedback. METER has Customer Service Representatives available to speak with you Monday through Friday, between 7 am and 5 pm Pacific time.

Note: If you purchased your WP4C through a distributor, please contact them for assistance.

Email:

support.environment@metergroup.com or sales.environment@metergroup.com

Phone:

509-332-5600

Fax:

509-332-5158

If contacting us by email or fax, please include as part of your message your instrument serial number, your name, address, phone, fax number, and a description of your problem or question.

1.2 About This Manual

Please read these instructions before operating your Potentia Meter to ensure that it performs at full potential. This manual includes instructions for setting up, calibrating, and maintaining the WP4C. Please read these instructions before operating WP4C to ensure that the instrument performs to its full potential. This manual will aid end users in understanding the basic concepts of water potential and enable them to use our instrument with confidence. Every effort has been made to ensure that the content of this manual is correct and scientifically sound.

1.3 Warranty

This device has a 30-day satisfaction guarantee and a one-year warranty on parts and labor. Your warranty is automatically validated upon receipt of the instrument.

1.4 Seller's Liability

Seller warrants new equipment of its own manufacture against defective workmanship and materials for a period of one year from the date of receipt of equipment.

Note: We do not consider the results of ordinary wear and tear, neglect, misuse, or accident as defects.

The Seller's liability for defective parts shall in no event exceed the furnishing of replacement parts "freight on board" the factory where originally manufactured. Material and equipment covered hereby which is not manufactured by Seller shall be covered only by the warranty of its manufacturer. Seller shall not be liable to Buyer for loss, damage or injuries to persons (including death), or to property or things of whatsoever kind (including, but not without limitation, loss of anticipated profits), occasioned by or arising out of the installation, operation, use, misuse, nonuse, repair, or replacement of said material and equipment, or out of the use of any method or process

for which the same may be employed. The use of this equipment constitutes Buyer's acceptance of the terms set forth in this warranty. There are no understandings, representations, or warranties of any kind, express, implied, statutory or otherwise (including, but without limitation, the implied warranties of merchantability and fitness for a particular purpose), not expressly set forth herein.

2 About the WP4C

2.1 Specifications

Range: 0 to -300 MPa¹

Accuracy: ± 0.05 MPa¹ from 0 to -5 MPa
1% from -5 to -300 MPa

Measurement Time:

- ~10 to 15 minutes for most soil samples in precise mode
- ~20 min. for plant tissue samples
- < 5 minutes in fast mode (reduced accuracy)

Temperature Control: 15 to 40 °C (± 0.2 °C)

Operating Environment: 5 to 40 °C (41 to 104 °F)

Sensor Type: A chilled-mirror dew point sensor and an Infrared temperature sensor

Sample Cup Capacity: 7 mL recommended (15 mL full)

Dimensions: 24.1 x 22.9 x 8.9 cm (9.5 x 9.0 x 3.5 in)

Weight: 3.2 Kg (7.1 lbs)

Case Material: Powder Painted Aluminum

Display: 20 x 2 alphanumeric LCD with backlighting

Data Communication: RS232A compatible, 8-data bit ASCII code, 9600 baud, no parity, 1 stop bit

Power: 110 VAC to 220 VAC, 50/60 Hz

Interface Cable: Standard RS232 to USB cable (included)

Compatible Standards: ASTM D6836-07

Warranty: One year parts and labor

¹The WP4C (and all vapor pressure instruments) are limited by accuracy in the wet end of the water potential range. The range of 0 to -5 MPa has an accuracy of 0.05 MPa. For example, a measurement at -0.1 MPa has an accuracy of $\pm 50\%$ of the reading and -1 MPa has an accuracy of $\pm 5\%$ of the reading. The WP4C will not measure water potential accurately near field capacity.

2.2 WP4C and Water Potential

Water potential is a measurement of the energy status of the water in a system. It indicates how tightly water is bound, structurally or chemically, within a substance. Water potential can be computed from the vapor pressure of air in equilibrium with a sample in a sealed measurement chamber. For a more detailed description of water potential, please refer to Chapter 9, titled “Theory: Water Potential” of this manual.

2.3 How the WP4C works

The WP4C uses the chilled mirror dew point technique to measure the water potential of a sample. In this type of instrument, the sample is equilibrated with the headspace of a sealed chamber that contains a mirror and a means of detecting condensation on the mirror. At equilibrium, the water potential of the air in the chamber is the same as the water potential of the sample. In the WP4C, the mirror temperature is precisely controlled by a thermoelectric (Peltier) cooler. A photoelectric cell detects the exact point at which condensation first appears on the mirror. The WP4C directs a beam of light onto the mirror, which reflects into a photodetector. The photodetector senses the change in reflectance when condensation occurs on the mirror. A thermocouple attached to the mirror then records the temperature at which condensation occurs. Values begin to be displayed indicating that initial measurements are being taken. WP4C then signals you by flashing a green LED and/or beeping when it reaches the final values. The instrument will display the final water potential and temperature of the sample.

In addition to the technique described above, WP4C uses an internal fan that circulates the air within the sample chamber to reduce time to equilibrium. Measuring both dew point and sample surface temperatures are simultaneously measured, this eliminates the need for complete thermal equilibrium. The WP4C controls the sample temperature by means of an internal thermo-electrical module that monitors and stabilizes the sample block temperature according to how it is set.

2.4 WP4C and Temperature

Large temperature differences, between sample and block, will cause longer reading times, since a complete and accurate reading will not be made until the difference between the sample temperature and the block temperature is less than 1.0 degree. To help you monitor the temperature difference between your sample and the block, you can access a Sample Equilibration screen at the Main menu.

3 Getting Started

3.1 Components of your WP4C

Your WP4C should have shipped with the following items.

- WP4C Main Unit
- Quickstart Guide
- Certificate of Calibration
- Power Cord
- RS-232 to USB Cable
- 25 Plastic Sample Cups and Lids
- 10 Stainless Steel Sample Cups
- Operator's Manual
- 12 Vials of 0.50 mol/kg KCl
- Cleaning Kit

3.2 Choosing a Location

To ensure that your WP4C operates correctly and consistently, place it on a level surface. This reduces the chance that sample material will spill and contaminate the inside of the instrument. To protect the internal electrical components, and to avoid inaccurate readings, place your WP4C in a location where the temperature remains fairly stable. This location should be well away from air conditioner and heater vents, open windows, outside doors, refrigerator exhausts, or other items that may cause rapid temperature fluctuation.

3.3 Features

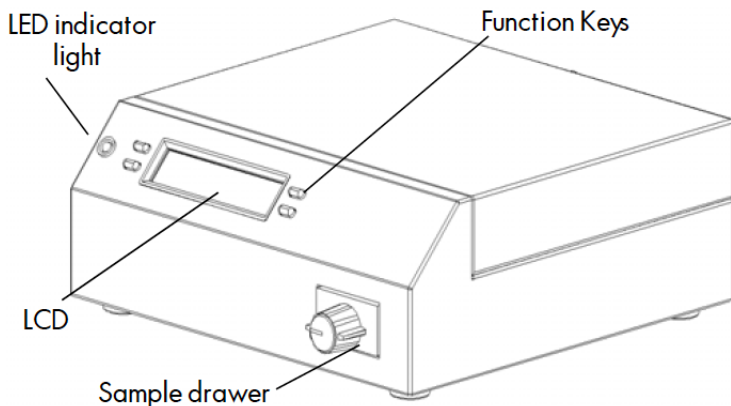

Figure 1: Front View of WP4C

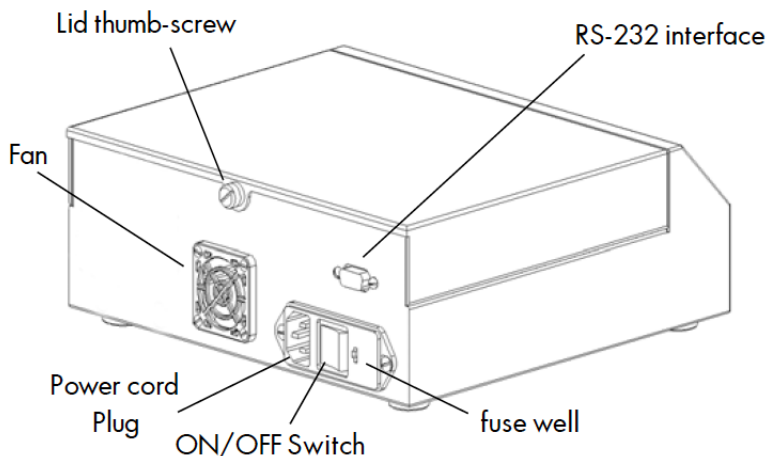
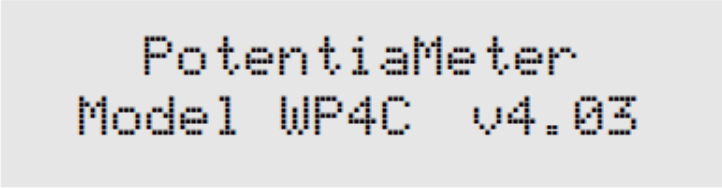

Figure 2: Back View of WP4C

3.4 Preparing the WP4C for Operation

After finding a good location for your WP4C, plug the power cord into the back of the unit. Before turning it on, pull open the sample drawer (turn the knob to the OPEN/LOAD position). You usually place an empty disposable sample cup upside-down in the drawer to

protect it during shipment. Remove this sample cup and turn the instrument on. The ON/OFF switch is located on the lower right corner of the WP4C back panel. The model and then the main menu will appear on the LCD.



Potentiometer
Model WP4C v4.03

Then:



P 0.00 MPa
pF 0.00 0.0°C

This is the Main menu, displaying the water potential in both Mega-Pascals (MPa) and pF, and the sample temperature in °C. In order to provide the most accurate readings, WP4C should ideally be allowed a warm-up period of 15 to 30 minutes after turning it on. When you insert a sample into the chamber drawer and turn the drawer knob to the READ position, the instrument will begin the read cycle to measure the water potential of your sample.

3.5 Portability

On occasion you may want to take water potential measurements in the field where it is not feasible to take samples and return to the lab. The following is a procedure for powering your WP4C using your vehicle as a power source at sites where AC power is not readily available.

1. Purchase a portable power inverter that plugs into the 12 V output (cigarette lighter) of your vehicle. The inverter should have a continuous output of at least 140 Watts.

2. Place the WP4C on a level surface. Care should be taken to minimize temperature gradients that may affect the instrument while in the field. A Styrofoam box, for example, will help minimize temperature effects.
3. Plug the 12-volt inverter to the 12-volt output of the vehicle, or directly to the battery itself.
4. Plug the WP4C to the inverter, and turn it on. When the instrument is on, it draws up to 1 amp. Check the rating of your battery if you want to know how long it will power the instrument (for example, if your battery is rated for 60 amp hours, it will work for 60 hours when the vehicle is not running).
5. Allow the instrument to warm up for 15 to 30 minutes as you would in the lab. Check the calibration of the instrument before proceeding with reading.

4 The Menu

4.1 The Main Menu

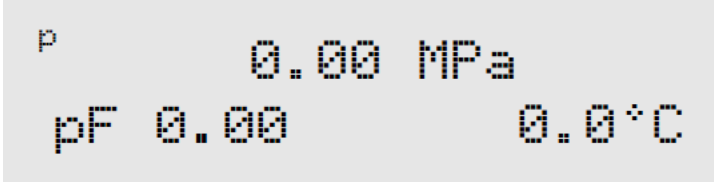

Every time you turn on your WP4C, it will open to this screen. If this screen does not appear, refer to Chapter 12 for troubleshooting instructions. The water potential and sample temperature displays on the screen. On each side of the LCD there are buttons. Each button performs a different function depending on which mode you want. Figure 3 provides a description of the modes and options you may use and the buttons that set them.

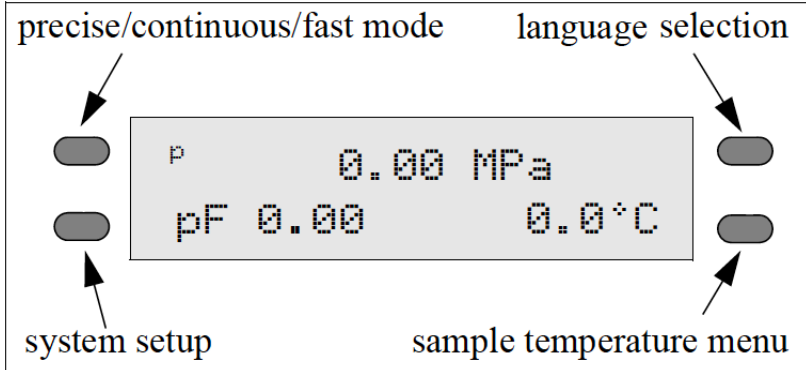
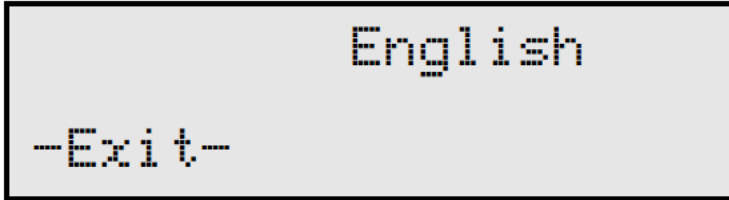

Figure 3: Main Menu Screen

4.1.1 Changing Languages

The WP4C comes to you with English as the default on-screen user language. If you prefer not to use English, you can change it to one of a variety of other languages: German, French, Spanish, Italian, Swedish, Danish, Norwegian, Czech, Portuguese, Japanese, Polish or

Finnish. Change languages by pressing the upper right button of the instrument while it is not reading a sample. You will see the Language screen with default English.



Press the upper right key again, and the next language option (German) will appear.

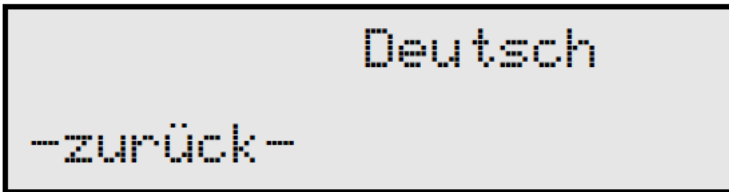

Each time you press the right button, the display will scroll to the next language option. Select the language you prefer and press the lower left button to exit.

4.1.2 Reading Modes

Precise Mode

When you first turn on the WP4C, it will be in precise mode. The WP4C repeats sample measurements until successive readings agree within a preset tolerance (0.03 MPa for $\Psi > -40$ MPa; otherwise 0.3 MPa). The WP4C always starts in precise mode. To toggle between the precise, continuous and fast modes, press the top left button. The display will show a small p, c or f to the left of the water potential readings.(Figure 4)

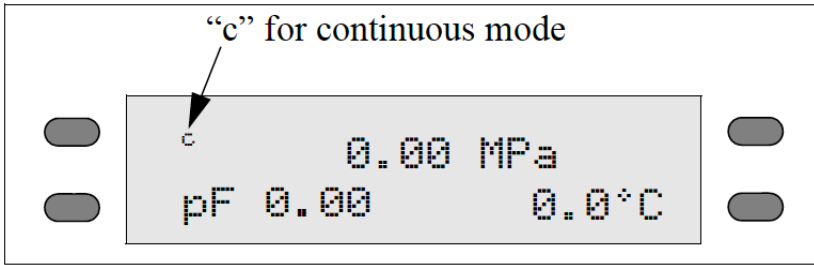

Figure 4: Main Menu with Continuous Mode Enabled

Precise mode ensures a precise water potential value by repeating measurements on a sample. Typical read times are within 10 to 15 minutes. The green LED blinks until you turn the drawer knob to the OPEN/LOAD position.

Continuous Mode

Continuous mode measures the water potential of your sample continuously until you turn the drawer knob to the OPEN/LOAD position. This can be useful in doing long term monitoring of samples that take an especially long time to come to vapor equilibrium, such as plant samples and moist soil samples with water potential > -0.5 MPa. In this mode the WP4C will measure the sample, stop to display the water potential and sample temperature, then begin another read cycle. Between samples, it will signal you with the green LED flash, accompanied by the beeper, if enabled. Some find it helpful to connect their WP4C to a computer while in continuous mode in order to log and store data over time. For instructions on how to do this, see Chapter 8.

Fast Mode

In fast mode, the sample is measured only once. Read time is typically 3 to 5 minutes. Readings are less precise, particularly in the wet range. However, fast mode is recommended for dry soil samples with water potential < -40 MPa.

4.2 System Configuration

If you press the bottom left button while in the Main menu, it will bring you to the System Configuration menu. This menu allows you to make minor system changes.(Figure 5 and 6)

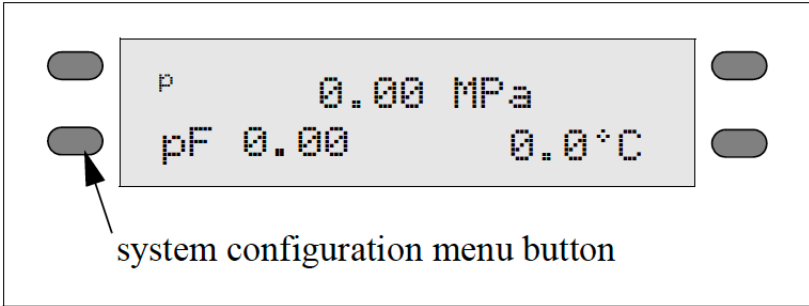

Figure 5: Main Menu Buttons

You can change how the beeper signals after each reading and enter the calibration menu as well.

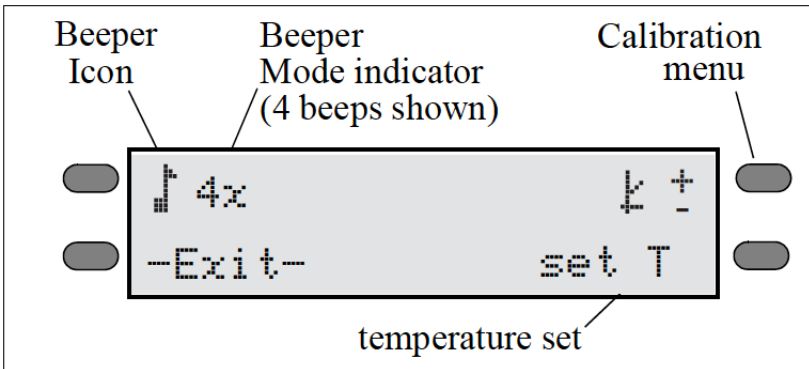

Figure 6: System Configuration Menu

Changing the Beeper

When you are reading, the WP4C has two ways of notifying you when it completes the water potential reading for your sample. It will notify you with the beeper he beeper and a flashing green LED,

located on the left front corner of the WP4C case. In fast and precise reading modes, the LED will flash once when a sample is started. When it is finished the LED will flash continuously until the knob is moved to the OPEN/LOAD position (if not operating in continuous mode). You cannot turn off or change the LED flashing functions.

Three different icons represent the three beeper options. (Figure 7)

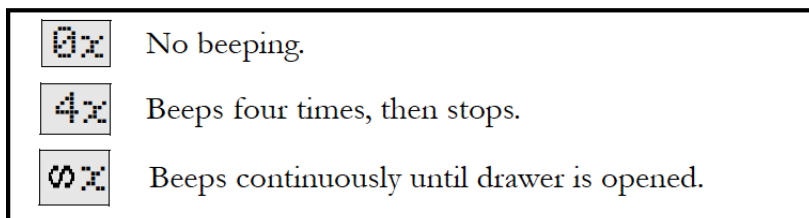

Figure 7: Definition of Beeper Icons

you can turn the beeper off completely, set it to beep momentarily (four times) when the sample is finished and then stop, or to beep continuously until you turn the knob to the OPEN/LOAD position. After you have adjusted the beeper setting, it will remain as you have set it until you change it again, and will not be affected by turning the instrument on or off.

EXIT

You may press the Exit button (the lower left button) to exit back to the main menu at any time.

Adjusting Calibration

When you need to adjust calibration, press the upper right button in the System Configuration menu, and you will be brought to the Calibration menu. For more details on calibration and how to verify it, please refer to the Calibration and Verification chapter.

Setting the Temperature

The WP4C gives you the ability to manually set your instrument sample chamber temperature. To set your instrument sample chamber temperature, press the lower right button next to the “set T” in the System Con

figuration menu. The following screen will appear:

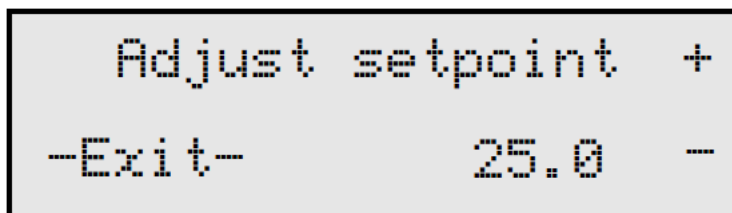

Adjusting the Setpoint Temperature

Use the buttons next to + and – to adjust the target setpoint temperature (displayed in the lower right corner). If you press either button it adjusts in increments of 0.1 °C.

Note: Holding down the button will rapidly increment the value.

The target setpoint temperature roughly corresponds to the temperature at which you wish the sample to read. Adjust the setpoint to the temperature that you want, then begin measurements to see how close your WP4C comes to your desired temperature (this works best by putting the WP4C in continuous mode). After several samples, it should show consistent temperature readings. At this point, make any needed adjustment to the setpoint index number to reach your desired temperature. You will be able to adjust the index number between 15 and 40 °C. If you press the – button after you reach 15 °C, it will disable the temperature control function until you raise the index number again. When the temperature control is disabled the display will show ‘off’ in place of the temperature setting.

Important tips with the WP4C

- Before reading, wait for approximately 30 minutes to let the chamber temperature stabilize after turning it on.

- Cool samples to a temperature slightly below chamber temperature before starting a reading.
- For slow equilibration samples, such as plant and moist soil samples (> -0.5 MPa), precise reading mode may yield small errors. For these types of samples, We recommend you use continuous mode and log data over time (See Chapter 8) to determine when equilibrium conditions are reached.
- For samples with very little water holding capacity (i.e. dry sand samples), small leaks in the sample chamber can cause water potential to drift down over time. Fast mode is recommended for these samples.
- For best results, run most soil samples in precise mode for best results.
- Never place a hot or warm sample in a cooled chamber, because condensation will form inside the chamber, causing errors in reading.

4.3 Sample Equilibration Screen

To see the temperature difference between your sample and the WP4C, press the lower right button at the main menu. You can only access the Temperature Difference screen when the drawer knob is in the OPEN/LOAD position.

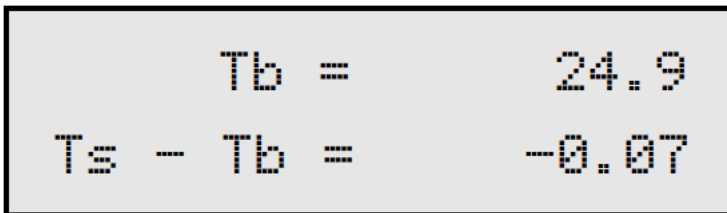

This screen shows the temperature difference between the sample (T_s) and the chamber block (T_b). This screen allows you to quickly check if the sample is too hot, which may cause condensation inside the chamber. Press the lower right button to exit.

Note:) It is important that $T_s - T_b$ is negative in order to prevent condensation inside the sample chamber.

5 Calibration and Verification

5.1 Verification

The WP4C uses the chilled mirror dew point technique for measuring water potential. This is the primary measurement method, though instrument cleanliness can affect the calibration. We fix the calibration slope during factory calibration. The user can adjust the zero offset and calibrate successfully with any solution of known water potential. We recommend using the 0.5 mol/kg KCl verification standard available from METER.

5.2 Verification Standards

Verification standards are specially prepared salt solutions that have a specific molality and water potential. The potassium chloride (KCl) verification standards are accurate, easy to use, and readily available from METER. Most importantly, they greatly reduce preparation errors.

The standards are produced under a strict quality assurance regime and are shelf stable for one year. If for some reason you cannot obtain METER's verification standards and need to make a salt solution for verification, refer to Appendix A.

Note: To avoid inaccurate water activity readings, verification standards should be used once immediately after opening and not stored in sample cups for repeated use.

5.3 When to Verify Calibration

The calibration of your WP4C should be checked with the KCl standard before each use. It can also be checked by measuring distilled water, but this is often not a good choice for checking calibration. When using distilled water, the humidity of the chamber approaches 100% which can cause condensation to occur if the sample is warmer than the chamber. For batch processing, you should regularly check

the instrument against the KCl standard. This will alert you to the possibility of contamination of the unit or shifts in the calibration from other causes.

5.4 How to Verify and Calibrate the WP4C

Since errors in the calibration value result in errors in all values subsequently measured, care should be taken to do it right.

Checking and Adjusting Calibration

- Press the upper right button in the System Configuration menu to enter the calibration menu. You will be guided through the calibration routine beginning with instructions to place your standard.

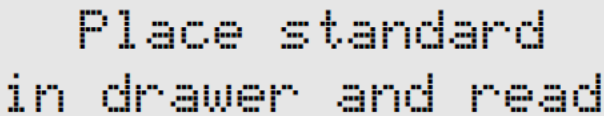

Place standard
in drawer and read

- Empty the whole vial of KCl solution into a sample cup and place it in the WP4C sample drawer. Make sure you calibrate using the same type of sample cup (plastic or stainless steel) that you will make subsequent measurements with.
- Carefully slide the drawer closed, being especially careful so the solution does not splash or spill and contaminate the chamber. Check to be sure the sample temperature is below chamber temperature (lower right button).
- Turn the drawer knob to the READ position to make a reading. When the reading is complete, the following screen will appear:

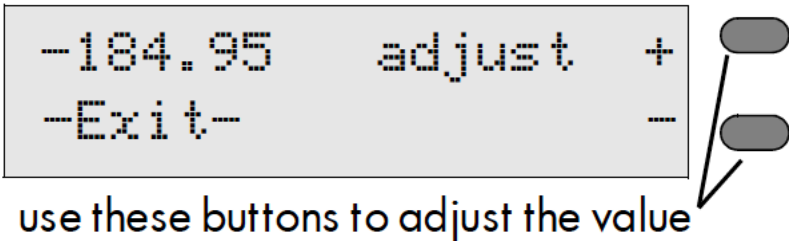

Note: The WP4C will automatically shift to precise sampling mode for the verification/calibration.

The reading should be within ± 0.05 MPa of the correct reading of the KCl standard at that temperature. At 20 °C this should be -2.19 MPa. At 25 °C this should be -2.22 MPa.

- If your WP4C is reading within 0.05 MPa of the KCl solution, press Exit and proceed with reading. If it is not, a change in calibration may have occurred, or the sensor chamber may be contaminated. For cleaning instructions, see Chapter 10. After cleaning, repeat these instructions.
- If, after cleaning, you consistently get readings that differ from the correct water potential of the KCl by more than ± 0.05 MPa, a change in calibration has probably occurred. Press the upper right button to move the value up, the lower right button to move it down. When it is at the correct value for the verification standard, press the Exit button. The value will be stored.

Note: This is the only menu where these buttons can change the calibration, so you will not hurt anything by pressing these buttons in other menus.

- Read the KCl standard again in the normal reading mode. It should read the proper value.
- If after adjusting the calibration and cleaning the chamber you still are getting incorrect readings when reading the KCl, contact METER at 509-332-5600 for further instructions.

6 Sample Preparation

Your WP4C will continually provide accurate water potential measurements as long as its internal sensors are not contaminated. Careful preparation and loading of samples will lengthen time between cleanings and will help you avoid downtime and repairs.

6.1 Choosing a Sample Cup

The WP4C comes with two types of samples cups: disposable plastic cups and stainless steel cups. The disposable plastic cups are adequate for most samples, but are not good for samples in the wet end. If you are measuring samples with water potential wetter than -1 MPa, you should use the stainless steel sample cups. You can also oven dry soil samples directly in the stainless steel cups to determine water content gravimetrically, which is convenient if you are generating soil moisture characteristic curves. It is important to note that you must thoroughly clean the stainless steel cups using deionized water between uses to prevent solutes from contaminating subsequent samples and causing artificially negative osmotic potential. Finally, if you calibrate the WP4C (see chapter 5), be sure to calibrate using the same type of sample cup that you intend to use for subsequent measurements.

6.2 Preparing the Sample

First, place the sample in a disposable sample cup, completely covering the bottom of the cup, if possible. WP4C may not be able to accurately measure a sample that does not (or cannot) cover the bottom of the cup. A larger sample surface area speeds up the reading by shortening the time needed to reach vapor equilibrium. It also increases instrument accuracy by providing more stable infrared sample temperature measurements.

Do not fill the sample cup more than half full. Overfilled cups may contaminate the sensors in the chamber, remember more is not necessarily better.

Make sure that the rim and outside of the sample cup are clean. Wipe any excess sample material from the rim of the cup with a clean tissue. Material left on the rim or the outside of the cup will contaminate the sensor chamber and will be transferred to subsequent samples. The rim of the cup forms a vapor seal with the sensor block when the drawer knob is turned to the READ position. Therefore, any sample material left on the cup rim will be transferred to the block, preventing this seal and contaminating future samples.

If a sample will be read at some future time, put the sample cup disposable lid on the cup to restrict water transfer. For short-term storage (< 3 hours) the cup lid is acceptable. If it will be a long time before the measurement is made, seal the lid with tape or Parafilm[®] completely around the cup and lid junction.

6.3 Dry Samples

Samples that have a water potential drier than about -300 MPa cannot be accurately measured with the WP4C. However, samples with such dry water potential values are rare. When a sample water potential value is drier than about -300 MPa, WP4C will display an error message indicating the lowest reading it could make on that particular sample. For example, if you were measuring a dry sample and the following screen appeared:



< -301.8 MPa

This screen indicates that the last water potential reading the WP4C measured on this sample was -301.8 Megapascals. Therefore, the actual water potential of the sample is lower than the instrument can measure.

6.4 Samples and Temperature

If samples are warmer than the chamber when they are placed in it ($T_s - T_b$ is a positive number), condensation may occur and moisture may condense inside the block. In order to prevent this, follow steps 1 and 2.

1. Place your sample in the chamber, slide the drawer closed and press the lower right button to access the sample temperature screen and look at the temperature difference. If the sample temperature is shown to be a positive number, take the sample out immediately and let it cool on a cold surface with the cup lid on it to preserve the moisture. Do not cool the sample too much, or the equilibrium time will be lengthened (ideally the $T_s - T_b$ will be between -0.5 and 0).
2. After cooling it for a minute or so, place the sample back in and note the temperature difference. If it is close enough to the block temperature, turn the knob to the READ position to begin reading.

There is a linear relationship between the sample dew point temperature and its water potential. The dew point decreases -0.12 °C per MPa. For example, a very dry sample at -40 MPa can be 4.8 °C ($-0.12 * -40$) above the chamber temperature without condensing. A sample at -1 MPa (fairly dry for most soils) can be 0.12 °C above the chamber temperature without condensing. Therefore, if you know the general range of your sample water potential, you can gauge at which temperature it will condense moisture. For samples that are more than 1 °C below chamber temperature, the WP4C waits until their temperature increases to 1 °C below chamber temperature to start a reading. Readings are therefore sped up if sample temperature is just a little below chamber temperature.

6.5 Measuring Plant Samples

The WP4C can be used to measure the water potential of leaves and plant material. Please refer to the application note: Measurement of Leaf Water Potential Using the WP4, which can be found at www.metergroup.com.

6.6 Taking a Reading

Once you have prepared your sample, you are ready to take readings. Follow steps 1 through 5 to take readings.

1. Turn the sample drawer knob to the OPEN/LOAD position and pull the drawer open.
2. Place your prepared sample in the drawer. Check the top lip of the cup to make sure it is free from sample residue (remember, an over-filled sample cup will contaminate the chamber sensors).
3. Carefully slide the drawer closed, being especially careful if you have a liquid sample that may splash or spill and contaminate the chamber.
4. Access the sample temperature menu (press lower right button) to watch the temperature difference between the sample and the instrument.
5. Turn the sample drawer knob to the READ position to seal the sample cup with the chamber. The instrument will beep once, and the green light will flash once to indicate that the reading cycle has started. In about 40 seconds, the first measurement will be displayed.

6.7 How WP4C takes Readings

The WP4C cooled mirror is controlled at the chamber dew point and its temperature is measured.. When the instrument has finished its read cycle, the water potential is displayed, accompanied by the LED flash and beeper (if you have the beeper enabled).

Cautions

- Never leave a sample in your WP4C after a reading has finished. The sample may spill and contaminate the instrument chamber if the instrument is accidentally moved or jolted.
- Never try to move your instrument after loading a sample. Movement may cause the sample material to spill and contaminate the sample chamber.
- Take special care not to move the sample drawer too quickly when loading or unloading liquid samples, in order to avoid spilling.
- If a sample has a temperature that is higher than the WP4C chamber ($T_s - T_b$ is a positive number), take the sample out immediately, put a cap on it, and cool it. Warm samples can cause condensation in the chamber and adversely affect subsequent readings.
- The physical temperature of the instrument should be between 5 °C and 40 °C. The WP4C will measure samples between this range quickly and accurately.
- If you are reading and a triangular warning symbol appears in the top right corner of the display, this indicates that the mirror has become too dirty to give accurate measurements. You will need to clean the mirror and chamber before continuing to sample. For more details about this symbol, please refer to Chapter 12. For cleaning instructions, refer to Chapter 10.

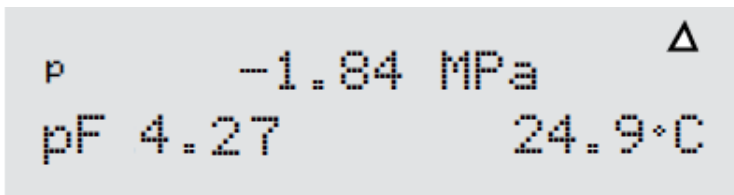

7 Computer Interface

Your WP4C comes with a RS-232 to USB Serial cable. Using this cable, you can connect to your WP4C and send water activity data to a computer for further analysis and storage. The interface is run through the AquaLink 4 Software or a terminal communication program.

Note: If your computer does not have a USB port, you can use a USB to RS-232 adapter.

7.1 AquaLink 4 Software

An optional software program, AquaLink 4, is available for use with your WP4C. AquaLink 4 is a Windows based program designed for data collection and customized report generation. AquaLink 4 logs water activity, temperature, time of measurement, and date stamps along with other information. AquaLink 4 also has sample identification and comment fields that you can use to help annotate the data your WP4C is gathering.

A 30 day trial USB of this program is attached to the front cover of this manual. If you are interested in purchasing a license of AquaLink 4, contact METER or your local distributor. On the next page is a sample picture of the AquaLink 4 program:

The screenshot shows the AquaLink 4.1.848 software window. The title bar reads 'AquaLink 4.1.848'. The menu bar includes 'File', 'Edit', 'View', 'Device', and 'Help'. Below the menu is a 'Connect Via' dropdown menu currently set to 'COM4 Decagon UCA'. To the right of the dropdown are icons for 'Connect', 'Download', 'Export', 'Models', and 'Chart'. The main area contains a data table with the following columns: Date Time, Device, Water Activity, °C, Test Time, User, Type, and Dew. The table lists 20 data points from 2000-Jan-01 to 2000-Jan-20. The status bar at the bottom indicates 'Status: Ready'.

Date Time	Device	Water Activity	°C	Test Time	User	Type	Dew
2000-Jan-01 00:00:00	S40001234	0.0000	0.00	0.0	Admin	Normal	Dew
2000-Jan-01 22:14:07	S40001234	0.0010	1.43	3.0	Admin	Normal	Dew
2000-Jan-02 20:28:14	S40001234	0.0020	2.86	2.9	Admin	Normal	Dew
2000-Jan-03 18:42:21	S40001234	0.0030	4.29	5.9	Admin	Normal	Dew
2000-Jan-04 16:56:28	S40001234	0.0040	5.72	5.8	Admin	Normal	Dew
2000-Jan-05 15:10:35	S40001234	0.0050	7.15	5.7	Admin	Normal	Dew
2000-Jan-06 13:24:42	S40001234	0.0060	8.58	5.5	Admin	Normal	Dew
2000-Jan-07 11:38:49	S40001234	0.0070	10.01	5.4	Admin	Normal	Dew
2000-Jan-08 09:52:56	S40001234	0.0080	11.44	5.3	Admin	Normal	Dew
2000-Jan-09 08:07:03	S40001234	0.0090	12.87	5.2	Admin	Normal	Dew
2000-Jan-10 06:21:10	S40001234	0.0100	14.30	5.1	Admin	Normal	Dew
2000-Jan-11 04:35:17	S40001234	0.0110	15.73	5.0	Admin	Normal	Dew
2000-Jan-12 02:49:24	S40001234	0.0120	17.16	4.8	Admin	Normal	Dew
2000-Jan-13 01:03:31	S40001234	0.0130	18.59	4.7	Admin	Normal	Dew
2000-Jan-13 23:17:38	S40001234	0.0140	20.02	4.6	Admin	Normal	Dew
2000-Jan-14 21:31:45	S40001234	0.0150	21.45	4.5	Admin	Normal	Dew
2000-Jan-15 19:45:52	S40001234	0.0160	22.88	4.4	Admin	Normal	Dew
2000-Jan-16 17:59:59	S40001234	0.0170	24.31	4.3	Admin	Normal	Dew
2000-Jan-17 16:14:06	S40001234	0.0180	25.74	4.1	Admin	Normal	Dew
2000-Jan-18 14:28:13	S40001234	0.0190	27.17	4.0	Admin	Normal	Dew
2000-Jan-19 12:42:20	S40001234	0.0200	28.60	3.9	Admin	Normal	Dew
2000-Jan-20 10:56:27	S40001234	0.0210	30.03	3.8	Admin	Normal	Dew

Figure 8: AquaLink Screen Shot

7.2 Using a Communication Program

There are several terminal program options. METER has its own terminal program (DecaTerm) which can be downloaded from <http://software.meter.com>. Two other options are TeraTerm, which is a free program that can be found on the Internet and Hyperterminal which came standard with Windows prior to Windows 7.

To use any of these terminal programs with your WP4C, follow the instructions for the program with the following settings. Be sure to power on the WP4C prior to connecting the USB interface cable to your computer.

- Choose correct Com port
- Set/Verify Com Properties
 - ✓ Bits per second 9600
 - ✓ 8 Databits
 - ✓ No parity

- ✓ 1 stop bit
- ✓ Flow control set to none

After successfully connecting the WP4C to your computer and upon completion of a water activity reading, the data will be displayed in the terminal program in the format as follows: measurement time (minutes), sample temperature, and water potential (in both Mega-Pascals and pF). Figure 9 shows a sample return.

time (minutes) since sample was started	temp (°C)	water potential	
		(MPa)	pF
3	24.3	-2.19	4.16

Figure 9: Sample Data Return

8 Theory: Water Potential

8.1 Water Potential

Water potential is defined as the potential energy per unit volume of water in a sample. The total water potential of a sample is the sum of four component potentials: gravitational, matric, osmotic, and pressure. Gravitational potential depends on the position of the water in a gravitational field. Matric potential depends on the adsorptive forces binding water to a matrix. Osmotic potential depends on the concentration of dissolved substance in the water. Pressure potential depends on the hydrostatic or pneumatic pressure on the water.

The WP4C measures the sum of the osmotic and matric potentials in a sample. Often one or the other of these potentials will be the dominant factor in determining the total potential. For example, solutions like the KCl calibration standard have only an osmotic component. Soils bind water mainly through matric forces, and therefore have mainly a matric component (though salt-affected soils can have a significant osmotic component).

8.2 Measuring Water Potential

The water potential of a solid or liquid sample can be found by relating the sample water potential reading to the vapor pressure of air in equilibrium with the sample. The relationship between the sample water potential (Ψ) and the vapor pressure of the air is:

$$\Psi = \frac{RT}{M} * \ln \frac{p}{p_o} \quad (1)$$

where p is the vapor pressure of the air, p_o is the saturation vapor pressure at sample temperature, R is the gas constant (8.31 J/mol K), T is the Kelvin temperature of the sample, and M is the molecular mass of water. The vapor pressure of the air can be measured using a chilled mirror, and p_o is computed from sample temperature.

The WP4C measures water potential by equilibrating the liquid phase water of the sample with the vapor phase water in the headspace

of a closed chamber, then measuring the vapor pressure of that headspace. In the WP4C, a sample is placed in a sample cup, which is sealed against a sensor block. Inside the sensor block is a fan, a dew point sensor, a temperature sensor, and an infrared thermometer. The dew point sensor measures the dew point temperature of the air, and the infrared thermometer measures the sample temperature. The purpose of the fan is to speed equilibrium and to control the boundary layer conductance of the dew point sensor.

From these measurements, the WP4C computes the vapor pressure of the air in the headspace as the saturation vapor pressure at dew point temperature. When the water potential of the sample and the headspace air are in equilibrium, the measurement of the headspace vapor pressure and sample temperature (from which saturation vapor pressure is calculated) gives the water potential of the sample.

In addition to equilibrium between the liquid phase water in the sample and the vapor phase, the internal equilibrium of the sample itself is important. If the sample is not at internal equilibrium, one might measure a steady vapor pressure (over the period of measurement) which is not the true water potential of the sample.

8.3 Effect of Temperature on Water Potential

Temperature plays a critical role in water potential determinations. Most critical is the measurement of the difference between sample and dew point temperature. If this temperature difference were in error by 1 °C, an error of 8 MPa would result. In order for water potential measurements to be accurate to 0.05 MPa, temperature difference measurements need to be accurate to 0.006 °C.

The WP4C infrared thermometer measures the difference in temperature between the sample and the block. It is carefully calibrated to minimize temperature errors, but achieving 0.006 °C accuracy is difficult when temperature differences are large. Best accuracy is therefore obtained when the sample is near chamber temperature.

Another effect of temperature on water potential occurs with samples

that are near saturation (like many soil samples). A sample that is close to 0.00 MPa and is only slightly warmer than the sensor block will condense water within the block. This will cause errors in the measurement, and in subsequent measurements until the condensation disappears. The Ts-Tb function helps the user ensure that the sample will not condense on the sensor block.

8.4 Estimating Osmotic Potential

The WP4C measures the sum of osmotic and matric potential. An approximate value for the osmotic potential can be found by measuring the electrical conductivity (EC) of the saturation extract of the soil. The osmotic potential of the saturation extract is computed from:

$$\Psi_{os}(MPa) = -0.036EC(dS/m) \quad (2)$$

The osmotic component of the water potential is then computed from:

$$\Psi = \Psi_{os}\left(\frac{\theta_s}{\theta}\right) \quad (3)$$

where θ is the volumetric water content of the sample and θ_s is the volumetric water content at saturation. The matric potential is the total potential minus the osmotic.

9 Cleaning and Maintenance

The accuracy of your WP4C is vitally dependent on keeping your instrument clean. Dust and sample debris can contaminate the sampling chamber and must therefore be regularly cleaned out. To clean your instrument, carefully follow these instructions. Your instrument ships with a cleaning kit that should last one year with regular cleanings. METER has additional cleaning kits available for purchase with supplies to clean your WP4C.

Note: Kimwipe[®] are included in the WP4C Cleaning Kit. They are ideal for cleaning because they do not leave much of a lint residue like most tissues. They also do not have any other compounds in the tissue that may contaminate the sensors in the WP4C block. Never use cotton swabs to clean the block sensors. Most cotton swabs contain adhesives and other compounds that are released and transferred to the mirror and other surfaces, contaminating them.

9.1 Accessing the Block

1. Unplug your WP4C
2. Remove the case lid screw located on the back panel. Carefully remove the lid by pulling the back of the lid upward and then sliding the lid back (away from the front of the case) and off.
3. Unscrew the two thumbscrews that secure the sensor block.
4. Unplug the cable with the 20-pin socket that attaches the block to the main circuit board by releasing the two locking levers that are on either side of the socket.
5. Carefully lift the block straight up from its mount. Turn the block over to expose the chamber cavity as shown in the illustration:

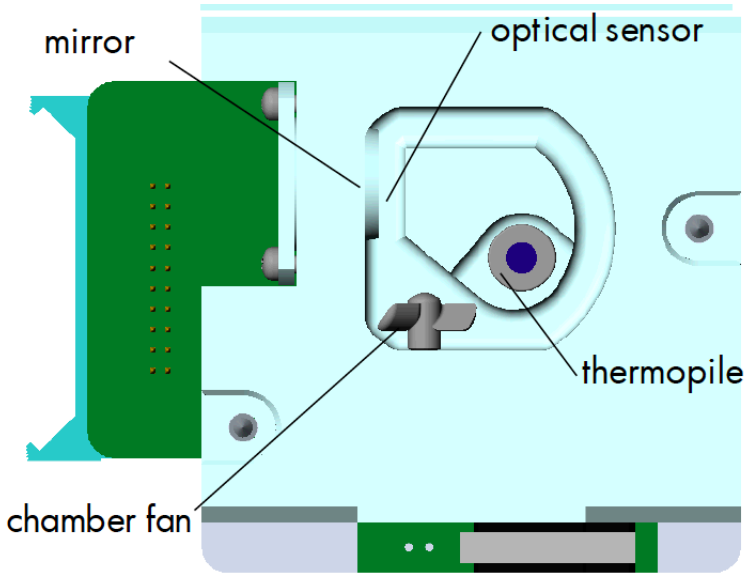

Figure 10: View of Inside Block

9.2 Cleaning Procedure

Cleaning your WP4C is a multi-step procedure which involves washing, rinsing, and drying for each specific area as outlined below:

1. Cleaning the Inside Chamber

Note: Be extremely careful not to damage the fan blades in the chamber. The fan blades are very fragile; if one of them breaks, your instrument will not work properly. Take extra care when cleaning this portion.

- (a) Remove any debris that may have collected within or around the sample chamber.
- (b) Wrap a new Kimwipe around the end of the thin plastic rod (spatula) and moisten it with isopropyl alcohol or cleaning solution.

Note: Do not dip a used Kimwipe into your container

of IPA or cleaning solution (the IPA or cleaning solution will become contaminated).

- (c) WASH—Clean all surface edges of the samples chamber including the edge where the sample cup seals to the chamber block. You may need to replace the Kimwipe if it becomes too dirty during this process.
- (d) RINSE—Repeat steps b and c using new Kimwipes with deionized water.
- (e) DRY—Repeat steps b and c using new, dry Kimwipes to help remove any moisture remaining from the cleaning.
- (f) Visually inspect the sample chamber for cleanliness. Clean again if necessary.

Note: Do not reuse Kimwipes.

2. Cleaning the Mirror

Note: Wash hands with soap and water (to prevent oils from contaminating the Kimwipe tissue and being transferred to the mirror).

- (a) Wrap a NEW Kimwipe around the end of the thin plastic rod (spatula) and moisten it with isopropyl alcohol or cleaning solution.
- (b) WASH—Carefully clean the mirror with the moist Kimwipe.
- (c) RINSE—Repeat steps b and c using new Kimwipes with deionized water.
- (d) DRY—Repeat steps b and c using new, dry Kimwipes to help remove any moisture remaining from the cleaning.
- (e) Visually inspect the mirror for cleanliness. Re-clean if necessary. Note: Do not reuse Kimwipes.

3. Cleaning the Optical Sensor

You will probably clean the optical sensor while you are cleaning the mirror, since they face each other in a very small gap.

Clean it in the same manner as described above for the mirror.

4. Cleaning the Thermopile

- (a) Wrap a new Kimwipe around the end of the thin plastic rod (spatula) and moisten it with isopropyl alcohol or cleaning solution.
- (b) WASH—Swipe the moistened Kimwipe across thermopile. (A single swipe is usually sufficient to remove contaminants.)
- (c) RINSE—Repeat steps a-b using new Kimwipes moistened with deionized water instead of cleaning solution.
- (d) DRY—Repeat steps a-b but use a new, dry Kimwipe to help remove any moisture remaining from the cleaning.
- (e) Visually inspect the thermopile for cleanliness. This sensor must be free of all dirt and lint. Re-clean if necessary.

5. Inside Case

- (a) Clean the sample drawer and drawer base as described above for the thermopile. Remove any debris that may have collected inside the case.
- (b) Check once more to make sure there is no contamination of the sample chamber cavity.
- (c) Replace the block, and insert the ribbon cable socket into to the 20-pin plug on the block. Lock it in place with the locking levers.
- (d) Screw the thumb-screws on the block back in until they are hand-tight.
- (e) Replace the case lid and secure the lid screw.

6. Connect the WP4C power cord.

9.3 Checking Calibration

After you have cleaned the chamber and other parts of your WP4C, it is important to check the instrument performance in order to correct for any calibration change that may have occurred during cleaning procedures.

Check the calibration of your instrument by measuring the water potential of the KCl standard. If a change has occurred, refer to chapter 5 for directions on how to recalibrate. If, after adjusting calibration your instrument is still not reading samples correctly, contact METER for technical support.

10 Repair Instructions

If your WP4C ever needs to be sent in for service or repair, call METER at 509-332-5600 or fax us at 509-332-5158. We will ask you for your address, phone number, and serial number. For non-warranty repairs, we will also ask for a payment method (such as a purchase order or credit card number), a repair budget, and billing address.

Note: If you purchased your WP4C from one of our international distributors, please contact them before contacting METER. They may be able to provide you with local service and help you remedy the problem.

10.1 Shipping Directions

When you ship your instrument back to us, please include with it a document with the complete shipping address, name and department of the person responsible for the instrument, and (most importantly) a description of the problem. This information will better help our technicians and our shipping department to expedite repair on your instrument and ship it back to you in good time.

All WP4Cs returning to METER for servicing must be accompanied with a Return Material Authorization (RMA) form. Prior to shipping the instrument, please contact a METER customer support representative to obtain an RMA.

Follow steps 1 through 6 to successfully and safely ship your instrument back to us.

1. If possible, ship your WP4C back in its original cardboard box with foam inserts. If this is not possible, use a box that has at least four inches of space between your instrument and each wall of the box. If you are not using the foam inserts, pack the box moderately tight with packing material, like styrofoam peanuts
2. Put your instrument in a plastic bag to avoid disfiguring marks from the packaging.

3. Do not ship your WP4C to us with the power cord; we have plenty here to use with your instrument, and it may damage the instrument in shipment.
4. Please review the RMA form and verify the ship to and bill to information, contact name, and problem description. If anything is incorrect, please contact a METER representative.
5. Tape the box in both directions so it will not break open in shipment.
6. Include the RMA number in the attention line on the shipping label.

Ship to:

METER Group, Inc.

ATTN: RMA (insert your RMA #)

2365 NE Hopkins Court

Pullman, WA 99163

10.2 Repair Costs

Manufacturers defects and instruments within the one-year warranty will be repaired at no cost. For non-warranty repairs (including cleanings for instruments in their warranty period), costs for parts, labor, and shipping will be billed to you. We have a minimum repair charge, and an extra fee will be charged for rush work. METER will provide an estimated repair cost, if requested.

10.3 Loaner Service

METER has loaner instruments to keep you measuring water activity while your instrument is being serviced. If your WP4C is still under calibration warranty or you have a service plan with your instrument, there is no charge for the loaner service.

11 Troubleshooting

WP4C is a high performance instrument, designed to have low maintenance and few problems if used with care. Unfortunately, sometimes even the best operators using the best instruments encounter technical difficulties. Here is a list of some problems that may occur. If you have encountered a problem that is not addressed here, or if these remedies still do not resolve your problem, contact METER at 509-332-5600 (for those outside the US). If purchased from a distributor, please contact the distributor for assistance first.

11.1 Problems and Solutions

The following table is a brief guide to help you quickly define solutions to your problems. For more detailed descriptions of these problems and their solutions, see the explanations below the table.

Table 1: Troubleshooting Quick Guide

If this problem occurs:	Refer to:
WP4C does not turn on	Problem #1
Long Read Time	Problem #2
Readings on KCl standards are too high/low to adjust	Problem #3
Reading < -301.8 MPa	Problem #4
Triangle appears in upper right corner	Problem #5
“Block Failure” appears on screen after turning on WP4C	Problem #6
“Set T” option no longer appears on System Configuration menu	Problem #7

1. PROBLEM

WP4C does not turn on.

SOLUTIONS:

- Check to make sure your power cord is securely attached to the back of the instrument and the power outlet.
- A power surge may have caused a fuse to blow. Follow steps 1 through 5 to change the fuses.
 1. Unplug the power cord from the wall and the instrument.
 2. Locate the panel where the power cord plugs in. The fuse box is on the right side of that panel. Press in on the release tab and pull the fuse-holder out.
 3. Pull the broken fuse(s) out and replace with a 2.0 Amp 250 V fuse. Caution: Do not use any other kind of fuse or you will risk damage to your instrument and void your warranty.
 4. Replace the fuse-holder and push it into the fuse-well until the release tab snaps into place.
 5. Reconnect the power cord and turn your instrument on. If the fuse blows again, a failed component may be causing the problem. Contact METER to make arrangements for repairs if your problem persists.

2. PROBLEM:

Readings are slow or inconsistent.

SOLUTION:

- The sample chamber may be dirty. Refer to Chapter 10 of the manual for directions on cleaning the sample chamber.
- Some samples absorb or desorb moisture very slowly, causing measurements to take longer than usual, and nothing can be done to speed up the process. Refer to Chapter 6 for further explanation.
- The fan blade inside the block chamber may be broken. If even the KCl standard takes a long time to read, and the sample chamber is clean, you may have a broken or bent chamber

fan blade. This is especially likely if you have just cleaned the chamber. If you suspect this may have happened, contact METER for details on replacement.

3. PROBLEM:

Water potential readings on KCl standards are too high or low and a calibration adjustment cannot be made any higher or lower.

SOLUTIONS:

- The thermopile in your chamber, which measures sample temperature, may have become contaminated. Refer to Chapter 10 for directions on cleaning.
- If you are not using METER's KCl verification standards, high readings may indicate that the salt solution you are using is not in equilibrium.

4. PROBLEM:

Message on screen displays the following(example):



< -301.8 MPa

SOLUTION:

- The sample is too dry for the instrument to read accurately. If your sample has a water potential that is above the detection limits of the instrument, this message will come up. Essentially, it means that there is not enough sample moisture to condense on the mirror and provide a reading.
- The mirror may be dirty. Try cleaning the mirror and chamber and measuring the sample again.

5. PROBLEM:

A small triangle appears in the upper right corner after reading:

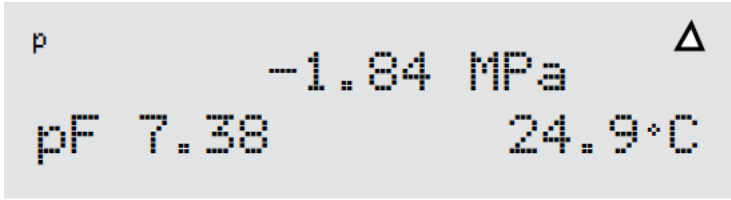
**SOLUTION:**

The mirror needs to be cleaned, along with the rest of the sample chamber, until it disappears. This triangle is a mirror performance indicator. When the WP4C senses that the mirror performance has dropped to unacceptable levels, it will display the triangular warning sign after measuring the sample. When this appears, you should stop sampling and clean the chamber. If the triangle is still on the screen after cleaning, the mirror is most likely still dirty and you will need to clean it until the triangle disappears.

6. PROBLEM:

“Block failure” message appears on screen.

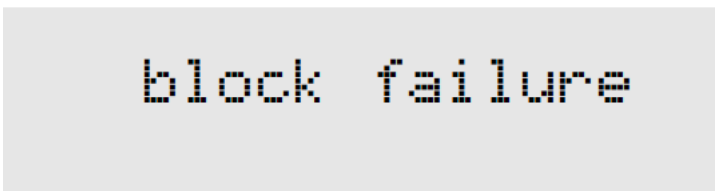
**SOLUTION:**

- The block is not plugged in to the motherboard. Open the case and check to make sure that the small ribbon cable that connects the block to the motherboard is snapped and locked in place.
- One or more components has failed on the block circuit board.

If the block is properly plugged in to the motherboard and this message appears, it is likely that one or more of the components have failed on the block circuit board.

7. PROBLEM:

The “Set T” option does not appear anymore in the WP4C System Configuration menu.

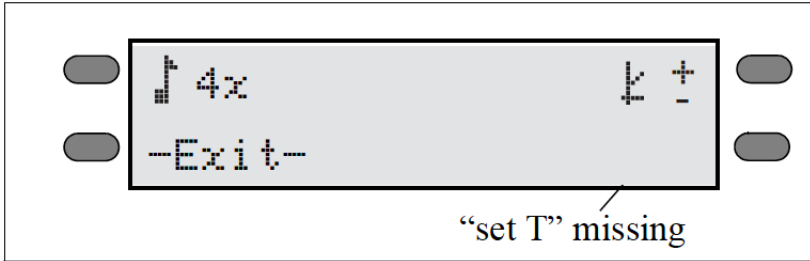

SOLUTION:

The temperature control module inside the WP4C is broken or not functioning correctly. When the instrument senses that there is a problem with the temperature control module, it removes that function as an option to the user as a precaution. Contact METER for service information.

11.2 Sensor Performance Screen

If, after cleaning your instrument and reviewing the troubleshooting items, you have reason to believe that one of the components of your WP4C may be causing measurement error, you can access a screen that will display values for component performance. Access this screen by holding down the lower right button while turning on the instrument. After it initializes, it will beep and come to the Performance Evaluation screen.

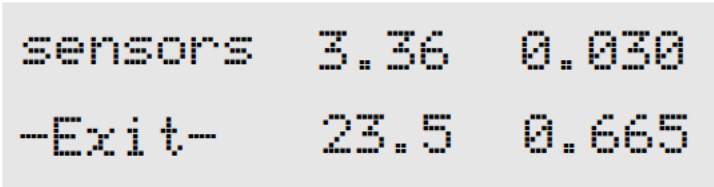

sensors	3.36	0.030
-Exit-	23.5	0.665

The Performance Evaluation screen gives you four values. The top left value is the value the thermocouple is reading. It is basically the difference in temperature between the block and the mirror. If this is zero, there is something wrong with the thermocouple. The top right value is the value read by the thermopile, which is the temperature difference between the block and what it “sees” below it (the sample, when reading). This value is variable, but should never be zero. The bottom left value is the block temperature. This value should be around ambient temperature.

The bottom right value is the mirror reflectance voltage, in units of volts. This value should normally be around 0.5 or above, but if it drops below 0.3, there is something wrong.

You cannot change anything in this screen, but it will indicate component performance. If you notice that any of these values are not what they should be, contact METER at support.environment@metergroup.com for further instruction. Press the button next to Exit to get back to the main menu.

12 Further Reading

References:

Brye, K.R., (2003). Long-term effects of cultivation on particle size and water-retention characteristics determined using wetting curves. *Soil Science Society of America* 168:7 459-468.

Campbell, E.C., G.S. Campbell, and W.K. Barlow., (1973). A dew point hygrometer for water potential measurement. *Agric. Meteor.* 12:113-121.

G.W. Gee, M.D. Campbell, G.S. Campbell, and J.H. Campbell., (1992). Rapid measurement of low soil water potentials using a water activity meter. *Soil Science Society of America* 56:4 1068-1070.

Papendick, R.I. and G.S. Campbell., (1980). Theory and measurement of water potential. in *Water Potential Relations in Soil Microbiology*. *Soil Science Society of America*. Madison, Wisconsin. pp. 1-22.

12.1 Application Notes

The following WP4C application notes are available from METER by request and from our website under the education tab, choose WP4C.

- *Generating a Soil Moisture Characteristic with the WP4C.*
- *Measuring Leaf Water Potential using the WP4C.*
- *Field Portability Instructions for the WP4C.*
- *Water Potential: The Key to Successful Seed Priming.*
- *Seed Longevity in Storage is Enhanced by Controlling Water Activity.*

- *Classification of Expansive Soils using the WP₄C Dew point PotentiaMeter*

13 Appendix A

13.1 Preparing Salt Solutions

Following is a table showing the water potential at given concentrations of NaCl and KCl at 20 °C.

Table 2: Water Potential of NaCl and KCl in Megapascals (MPa)

Concentration (Moles/kg)	NaCl	KCl
0.05	-0.232	-0.232
0.10	-0.454	-0.452
0.20	-0.901	-0.888
0.30	-1.349	-1.326
0.40	-1.793	-1.760
0.50	-2.242	-2.190
0.60	-2.699	-2.622
0.70	-3.159	-3.061
0.80	-3.618	-3.501
0.90	-4.087	-3.931
1.00	-4.558	-4.372

14 Appendix B

Temperature Correction of METER's Verification Standards

Table 3: Water Activity of Selected Salt Solutions

Temp. (°C)	H ₂ O	0.50 mol/kg KCL	2.33 mol/kg NaCL	6.00 mol/kg NaCL	8.57 mol/kg LiCl	13.41 mol/kg LiCl	17.18 mol/kg LiCl
15.0	1.000	0.984	0.923	0.761	0.492	0.238	0.140
20.0	1.000	0.984	0.922	0.760	0.496	0.245	0.145
25.0	1.000	0.984	0.920	0.760	0.500	0.250	0.150
30.0	1.000	0.984	0.920	0.760	0.504	0.255	0.155
35.0	1.000	0.984	0.920	0.760	0.508	0.261	0.160
40.0	1.000	0.984	0.921	0.760	0.512	0.266	0.165
50.0	1.000	0.984	0.894	0.740	0.517	0.275	0.172

15 Declaration of Conformity

Application of Council Directive: 2004/108/EC and 2011/65/EU

Standards to which conformity is declared: EN 61326-1:2013 and
EN 50581:2012

Manufacturer's Name: METER Group, Inc 2365 NE
Hopkins Ct. Pullman, WA 99163
USA

Type of Equipment: Dew Point PotentiaMeter

Model Number: WP4C

Year of First Manufacture: 2010

This is to certify that the Dew Point PotentiaMeter, manufactured by METER Group, Inc., a corporation based in Pullman, Washington, USA meets or exceeds the standards for CE compliance as per the Council Directives noted above. All instruments are built at the factory at METER and pertinent testing documentation is freely available for verification.

16 Certificate of Traceability

METER Group, Inc.
2365 NE Hopkins Court
Pullman WA 99163 USA

Tel: 509-332-5600
Fax: 509-332-5158
support.environment@metergroup.com

This NIST seal certifies that METER Group, Inc. manufactures all WP4C Dew Point Potential Meters according to temperature standards with calibration traceable to the National Institute of Standards and Technology (NIST).

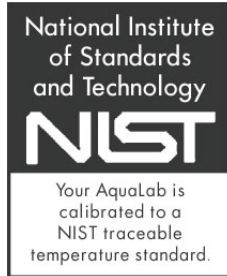

Index

- Accessories, 7
- Application Notes, 46
- AquaLink 4 Software, 27
- Beeper, 14, 44
- Block Failure, 40, 43
- Block Sensors, 33
- Buttons
 - Menu Selection, 11
- C for Continuous Mode, 13
- Calibration
 - Changes In, 19
 - Checking, 37
 - Drift, 19
 - Menu, 15
 - Steps, 20
 - When to Check, 19
- Cautions, 26
- CE Compliance, 50
- Certificate of Traceability, 51
- Chilled Mirror Technique, 5
- Cleaning, 33
 - Inside Case, 36
 - Inside Chamber, 34
 - Optical Sensor, 35
 - Sensor Block, 33
 - Thermopile, 36
- Components, 7
- Computer Interface, 27
- Contact Information, 1
- Cotton Swabs
 - Not for Cleaning, 33
- Customer Support, 1
- DecaTerm Program, 28
- Declaration of Conformity, 50
- Dirty Mirror Indicator, 26
- Distilled Water, 19
- Dry Samples, 23, 42
- Dry Water Potential, 23
- Email, 1, 51
- Error Messages, 40
- Exit, 15
- Fan
 - Inside Sample Chamber, 31
- Fax Number, ii
- Features, 8
- Field Measurements, 9
- Further Reading, 46
- Fuse
 - Changing, 41
- Gravitational Potential, 30
- Hyperterminal, 28
- KCl Standards, 19
- Languages
 - Changing, 11
 - Czech, 11
 - Danish, 11
 - Finnish, 12
 - French, 11
 - German, 11
 - Italian, 11
 - Japanese, 11
 - Norwegian, 11
 - Polish, 11
 - Portuguese, 11

- Spanish, 11
- Swedish, 11
- Leaf
 - Measuring Water Potential in
 - Continuous Mode, 13
- LED, 14, 44
- Linear Offset
 - Adjusting for, 20
- Loaner Service, 39
- Location
 - for Reading, 7
- Main Menu, 8, 11
- Maintenance, 33
- Matric Potential, 30
- Menu
 - Main Menu, 11
 - System Configuration, 14
- Molality
 - Verification Standards, 19
- Osmotic Potential, 30, 32
- Peltier Cooler, 5
- Phone Number, ii
- Plant Samples, 25
- Portability, 9
- Preparing Salt Solutions, 48
- Pressure Potential, 30
- Read Time
 - Affected by Sample Temperature, 24
 - Long, 40, 41
- Reading Modes, 12
 - Continuous, 13
 - Fast, 13
 - Precise, 12
- Readings
 - Cautions, 26
 - How WP4C Takes, 25
 - Taking Readings, 25
- References, 46
- Repair
 - Costs, 39
 - Instructions, 38
 - Shipping, 38
- Sample
 - Dry Water Potential, 23
 - Not at Room Temperature, 24
 - Preparation, 22
 - Slow Water Emitting, 41
 - Spilling, 26
 - Too Dry, 42
 - Too Hot, 26
- Sample Cups
 - Cleaning, 22
 - Filling, 22
 - Sealing, 22
- Sample Equilibration Screen, 17
- Saturated Salts, 48
- Seller's Liability, 2
- Sensor Performance Screen, 44
- Specifications, 4
- Technical Support, 1
- Temperature
 - Effect on Water Potential, 31
 - Hot Samples, 26
 - Impact on Readings, 6
 - Instrument, 26
 - Samples not at Room Temperature, 24
 - Setting, 15
- Triangle, 40, 43
- Troubleshooting, 40
- USB

- Driver, 28
- Interface Cable, 27

- Vapor Pressure, 30, 31
- Verification Standards, 19
 - Long Read Times for, 42
 - Water Potential too High/Low, 42

- Warm-Up, 10
- Warranty, 2
- Water Content, 30
 - vs Water Potential, 30
- Water Potential, 30
 - Definition, 5
 - Displayed, 8
 - Equation, 30
 - Measurement, 30
 - Theory, 30
- WP4C
 - and Temperature, 6
 - Chilled Mirror Dew Point Technique, 5
 - Important Tips, 16
 - Measuring Water Potential, 30
 - Preparing for Operation, 8
 - Theory, 30
- WP4C Readings
 - Cautions, 26